





Art.	Descrizione	Description																								
25FC0101 25FC0102 25FC0103 25FC0104	PINZE - MORSETTI - SOSTEGNI Agitatori in acciaio inox 18/8 lunghezza dell'asta: 300 mm, ø 7 mm. Paletta verticale, ø elica 10x50 mm Paletta orizzontale, ø elica 50x10 mm Palette incrociate, ø elica 50x20 mm Paletta forata, 70x70 mm	FORCEPS - CLAMPS - SUPPORTS 18/8 stainless steel stirrers. 300 mm long, 7 mm ø rod. Vertical blade, ø propeller 10x50 mm Horizontal blade, ø propeller 50x10 mm Crossed blades, ø propeller 50x20 mm Perforated blade, 70x70 mm																								
	 Art. 25FC0101	 Art. 25FC0102																								
	 Art. 25FC0103	 Art. 25FC0104																								
25FC0106 25FC0107 25FC0108	Palette snodate, ø elica 50 mm Palette orizzontali, ø elica 100x20 mm Paletta ad elica, ø elica 50 mm	Articulated blades, ø propeller 50 mm Horizontal blades, ø propeller 100x20 mm Propeller blade, ø propeller 50 mm																								
	 Art. 25FC0106	 Art. 25FC0107																								
	 Art. 25FC0108																									
25FC0197 25FC0198	<table border="1"> <thead> <tr> <th colspan="3" data-bbox="279 1422 790 1467">Capsule in nikel a forma emisferica con becco</th> </tr> <tr> <th data-bbox="327 1444 391 1467">ø mm</th> <th data-bbox="470 1444 534 1467">h mm</th> <th></th> </tr> </thead> <tbody> <tr> <td data-bbox="343 1489 375 1512">80</td> <td data-bbox="494 1489 526 1512">40</td> <td></td> </tr> <tr> <td data-bbox="335 1512 383 1534">100</td> <td data-bbox="494 1512 526 1534">50</td> <td></td> </tr> </tbody> </table>	Capsule in nikel a forma emisferica con becco			ø mm	h mm		80	40		100	50		<table border="1"> <thead> <tr> <th colspan="3" data-bbox="885 1422 1396 1467">Nickel evaporating dishes, hemispherical with lip.</th> </tr> <tr> <th data-bbox="933 1444 997 1467">ø mm</th> <th data-bbox="1077 1444 1141 1467">h mm</th> <th></th> </tr> </thead> <tbody> <tr> <td data-bbox="949 1489 981 1512">80</td> <td data-bbox="1101 1489 1133 1512">40</td> <td></td> </tr> <tr> <td data-bbox="941 1512 989 1534">100</td> <td data-bbox="1101 1512 1133 1534">50</td> <td></td> </tr> </tbody> </table>	Nickel evaporating dishes, hemispherical with lip.			ø mm	h mm		80	40		100	50	
Capsule in nikel a forma emisferica con becco																										
ø mm	h mm																									
80	40																									
100	50																									
Nickel evaporating dishes, hemispherical with lip.																										
ø mm	h mm																									
80	40																									
100	50																									
	 Art. 25FC0197....25FC0198																									

Art.	Descrizione	Description
	BACINELLE, BICCHIERI, SECCHI, IN ACCIAIO INOX 18/8 SERIE 112	BASINS, CUPS, BUCKETS IN 18/8 STAINLESS STEEL SERIES 112
25FC2360/00	Bacinella circolare con bordo, ø 280 mm., altezza 110 mm. Capacità litri 4,5.	Circular basin with rim, ø 280 mm, height 110 mm. Capacity 4.5 litres.
25FC2050/12	Bacinella circolare con becco , ø 120 mm., altezza 60 mm. Capacità litri 0,7.	Circular basin with lip , ø 120 mm, height 60 mm. Capacity 0.7 litres.
25FC2050/15	Come detta , ø 150 mm., altezza 70 mm. Capacità litri 0,9.	As above , ø 150 mm, height 70 mm. Capacity 0.9 litres.
25FC2050/20	Come detta , ø 200 mm., altezza 100 mm. Capacità litri 2.	As above , ø 200 mm, height 100 mm. Capacity 2 litres.
25FC2050/24	Come detta , ø 240 mm., altezza 150 mm. Capacità litri 5.	As above , ø 240 mm, height 150 mm. Capacity 5 litres.
25FC2430/06	Bacinella rettangolare altezza 55 mm. Base 250x180 mm. Capacità litri 1,8.	Rectangular basin , height 55 mm. Base 250x180 mm. Capacity 1.8 litres.
25FC2430/07	Come detta , 300x220 mm. Capacità litri 2,8.	As above , 300x220 mm. Capacity 2.8 litres.
25FC2430/08	Come detta , 350x260 mm. Capacità litri 4.	As above , 350x260 mm. Capacity 4 litres.
25FC2430/09	Come detta , 400x300 mm. Capacità litri 5.	As above , 400x300 mm. Capacity 5 litres.
		
<p>Art. 25FC2360/00 Art. 25FC2050/12...25FC2050/24 Art. 25FC2430/06...25FC2430/09</p>		
25FC2441/20	Bicchiere con manico e becco , ø 120 mm., altezza 120 mm. Capacità litri 1,2.	Cup with handle and lip , ø 120 mm, height 120 mm. Capacity 1.2 litres.
25FC2441/25	Come detto , ø 140 mm., altezza 140 mm. Capacità litri 2.	As above , ø 140 mm, height 140 mm. Capacity 2 litres.
25FC2441/30	Come detto , ø 160 mm., altezza 160 mm. Capacità litri 3.	As above , ø 160 mm, height 160 mm. Capacity 3 litres.
25FC2442/20	Bicchiere con bordo arrotondato , ø 120 mm., altezza 120 mm. Capacità litri 1,2.	Cup with rounded rim , ø 120 mm., height 120 mm. Capacity 1.2 litres.
25FC2442/25	Come detto , ø 140 mm., altezza 140 mm. Capacità litri 2.	As above , ø 140 mm, height 140 mm. Capacity 2 litres.
25FC2442/30	Come detto , ø 160 mm., altezza 160 mm. Capacità litri 3.	As above , ø 160 mm, height 160 mm. Capacity 3 litres.
25FC2350/10	Secchio con manico e graduato internamente , ø 270 mm., altezza 250 mm. Capacità litri 10.	Bucket with handle and internal graduated scale , ø 270 mm, height 250 mm. Capacity 10 litres.
25FC2350/12	Come detto , ø 290 mm., altezza 290 mm. Capacità litri 12.	As above , ø 290 mm, height 290 mm. Capacity 12 litres.
25FC2350/15	Come detto , ø 310 mm., altezza 320 mm. Capacità litri 15.	As above , ø 310 mm, height 320 mm. Capacity 15 litres.
		
<p>Art. 25FC2441/20...25FC4441/30 Art. 25FC2442/20...25FC4442/30 Art. 25FC2350/10...25FC2350/15</p>		

Art.	Descrizione	Description
	Capsule emisferiche acciaio inox 18/8	18/8 stainless steel hemispherical dishes.
	ø mm h mm	ø mm h mm
25FC205/04	40 25	40 25
25FC205/06	60 35	60 35
25FC205/08	80 45	80 45
25FC205/10	100 55	100 55
	Crogioli in acciaio 18/8	18/8 stainless steel crucibles
	ø mm h mm	ø mm h mm
25FC0172	35 30	35 30
25FC0173	40 35	40 35
25FC0174	45 40	45 40
25FC0175	50 45	50 45
25FC0176	60 55	60 55
	Coperchi per detti	Covers for the above
	ø mm h mm	ø mm h mm
25FC0178	35 —	35 —
25FC0179	40 —	40 —
25FC0180	45 —	45 —
25FC0181	50 —	50 —
25FC0182	60 —	60 —
	Crogioli in nikel puro	Pure nickel crucibles
	ø mm h mm	ø mm h mm
25FC0184	35 30	35 30
25FC0185	40 35	40 35
25FC0186	45 40	45 40
25FC0187	50 45	50 45
25FC0188	60 55	60 55
	Coperchi per detti	Covers for the above
	ø mm h mm	ø mm h mm
25FC0190	35 —	35 —
25FC0191	40 —	40 —
25FC0192	45 —	45 —
25FC0193	50 —	50 —
25FC0194	60 —	60 —

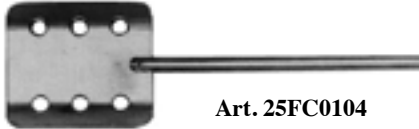
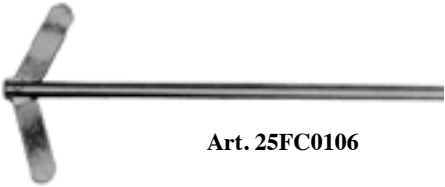
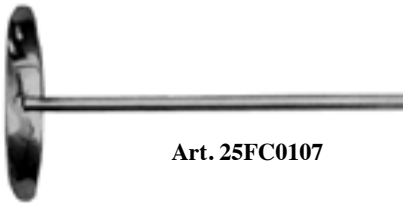
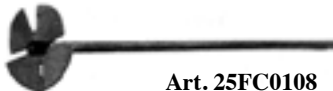





Art. 25FC205/04 - 25FC205/10







Art. 25FC0172 - 25FC0177
Art. 25FC0184 - 25FC0189



Art. 25FC0178 - 25FC0182
Art. 25FC0190 - 25FC0194

Art.	Descrizione	Description
<p>25FC0211</p> <p>25FC0212</p> <p>25FC0214</p> <p>25FC0216</p>	<p>Forcella portalampada con piattello</p> <p>Foratappi a mano in ottone lucido ad impugnatura fissa Per serie da 6 pezzi Per serie da 12 pezzi Per serie da 18 pezzi</p>	<p>Lamp holder with plate</p> <p>Manual hole punchers in mirror-finish brass with fixed handgrip. 6 piece set 12 piece set 18 piece set</p>
 <p data-bbox="469 831 624 855">Art. 25FC0211</p>		 <p data-bbox="1050 813 1334 837">Art. 25FC0212 - 25FC0216</p>
<p>25FC0218</p>	<p>Affila foratappi, con lama in acciaio temprato, manico in legno Per serie da 18 pezzi</p>	<p>Hole puncher sharpener with hardened steel blade and wooden handle. 18 piece set</p>
 <p data-bbox="837 1321 997 1346">Art. 25FC0218</p>		
<p>25FC0294</p> <p>25FC0295</p> <p>25FC0296</p> <p>25FC0293</p> <p>25FC0297</p>	<p>Morsetto doppio in lega speciale antiacida e anticorrosiva ø aste mm 13 16 21 25 Morsetto doppio, girevole in lega speciale, antiacida e anticorrosiva per aste ø mm 16.</p>	<p>Double clamp in special acid corrosion resistant alloy ø Rod mm 13 16 21 25 Double clamp in special acid and corrosion resistant alloy for rods up to 16 mm ø .</p>
 <p data-bbox="370 1930 654 1955">Art. 25FC0293 - 25FC0296</p>		 <p data-bbox="1114 2049 1273 2074">Art. 25FC0297</p>

Art.	Descrizione	Description
<p>25FC0300</p> <p>25FC0305 25FC0307 25FC0309</p>	<p>Morsetto doppio in lega speciale cromato smontabile per aste \varnothing mm 12.</p> <p>Morsetto doppio con volantini per aste \varnothing mm 12.</p> <p>Morsetto con asta semplice per aste fino a \varnothing mm 18.</p> <p>Morsetto doppio in ottone cromato tipo artiglio, per agitatori con aste \varnothing mm 18.</p>	<p>Removable double clamp in special chromium plated alloy for rods up to 12 mm \varnothing</p> <p>Double clamp with hand wheels for rods up to 12 mm \varnothing</p> <p>Simple rod clamp for rods up to 18 mm \varnothing</p> <p>Chromium plated brass claw-type double clamp for stirrers with rods up to 18 mm \varnothing.</p>
	 <p data-bbox="268 730 424 757">Art. 25FC0300</p>  <p data-bbox="820 721 976 748">Art. 25FC0305</p>  <p data-bbox="1171 824 1327 851">Art. 25FC0309</p>  <p data-bbox="520 940 676 967">Art. 25FC0307</p>	
<p>25FC0319</p> <p>25FC0320</p> <p>25FC0316</p> <p>25FC0317</p> <p>25FC0318</p> <p>25FC0645</p>	<p>Pompa per vuoto in ottone cromato con vuotometro con attacco portagomma.</p> <p>Pompa per vuoto in ottone cromato con vuotometro con attacco per rubinetto per 1/2" gas.</p> <p>Pompa per vuoto in ottone cromato con camera ispezionabile con attacco portagomma.</p> <p>Pompa per vuoto in ottone cromato con camera ispezionabile con attacco a vite per rubinetto 1/2" gas.</p> <p>Pompa per vuoto in ottone cromato con camera ispezionabile con attacco a vite per rubinetto 3/4" gas.</p> <p>Manometro vuotometro con quadrante graduato: da 0 a 76 cm.Hg.</p>	<p>Chromium plated brass vacuum pump with vacuum gauge with hose connection.</p> <p>Chromium plated brass vacuum pump with vacuum gauge and 1/2" gas cock connection.</p> <p>Chromium plated brass vacuum pump with inspection chamber and hose connection.</p> <p>Chromium plated brass vacuum pump with inspection chamber and 1/2" gas cock screw connection.</p> <p>Chromium plated brass vacuum pump with inspection chamber and 3/4" gas cock screw connection.</p> <p>Vacuum gauge with graduated dial from 0 to 76 cm mercury.</p>
	 <p data-bbox="392 1648 549 1675">Art. 25FC0319</p>  <p data-bbox="1062 1527 1219 1554">Art. 25FC0316</p>  <p data-bbox="772 2056 928 2083">Art. 25FC0645</p>	

Art.	Descrizione	Description
25FC0327	Pinza per vetrini di Kuenhe a morsi piatti in acciaio inox 18/8 lunghezza mm 105.	Kuenhe slides tweezers with flat offset jaws, in 18/8 stainless steel, 105 mm long.
25FC0349	Pinza per vetrini di Kuenhe a pale incrociate in acciaio inox 18/8 lunghezza mm 95.	Kuenhe slides tweezers with curved self-locking offset jaws, in 18/8 stainless steel, 95 mm long.
25FC0339	Pinze per microscopia a punte sottili diritte in acciaio inox 18/8: mm. lung. 105 125 140	Microscopy tweezers with fine straight jaws in 18/8 stainless steel: length mm 105 125 140
25FC0340		
25FC0341		
25FC0343	Pinze per microscopia a punte sottili curve in acciaio inox 18/8: mm. lung. 105 125 140	Microscopy tweezers with fine curved jaws in 18/8 stainless steel : length mm 105 125 140
25FC0344		
25FC0345		



Art. 25FC0327



Art. 25FC0349



Art. 25FC0339 - 25FC0341



Art. 25FC0343 - 25FC0345

25FC0333	Pinze , con punte arrotondate, in acciaio inox 18/8. mm. lung. 200 250 300
25FC0335	
25FC0338	

25FC0333	Tweezers in 18/8 stainless steel with rounded points. length mm 200 250 300
25FC0335	
25FC0338	



Art. 25FC0333 - 25FC0338

Art.	Descrizione	Description
25FC0377 25FC0378 25FC0380	Pinze per crogioli a doppia curvatura in acciaio inox 18/8 mm. lung. 220 300 500	Double bending crucible tongs in 18/8 stainless steel length mm 220 300 500
25FC0355	Pinza per bicchieri Becher da 100 a 1500 cc in acciaio inox 18/8 con protezione di sughero all'interno delle branche, lunghezza mm 310.	Forcep for beakers from 100 to 1500 cc, in 18/8 stainless steel with inner cork protection for jaws, 310 mm long.
25FC0356	Pinza per matracci e palloni da 100 a 2000 cc in acciaio inox 18/8 con palette rivestite di sughero, lunghezza mm 250.	Forcep for 100 to 2000 cc flat-bottomed and round bottomed flasks, in 18/8 stainless steel with inner cork protection for jaws, 250 mm long.
25FC0357	Pinza per capsule da \varnothing mm 70 a mm 125, in acciaio inox 18/8, lunghezza mm 240.	Forcep for \varnothing 70 mm to 125 mm evaporating dishes, in 18/8 stainless steel, 240 mm long.
25FC0358	Pinza per Becher da 100 a 1500 cc, in acciaio inox 18/8 rivestita in PVC, lunghezza mm 280	Forcep for 100 to 1500 cc beakers, in PVC lined 18/8 stainless steel, 280 mm long.



Art. 25FC0377 - 25FC0380



Art. 25FC0355







Art. 25FC0356







Art. 25FC0357



Art. 25FC0358

Art.	Descrizione	Description
<p>25FC0399 25FC0400</p> <p>25FC0409 25FC0411 25FC0412 25FC0413</p> <p>25FC0415 25FC0416 25FC9417</p>	<p>Pinza ragno in lega antiacida e anticorrosiva, dotata di rulli girevoli in PVC che permettono di alzare o abbassare la buretta automaticamente con una sola mano. Modello per una buretta. Modello per due burette.</p> <p>Pinze di Hoffmann in ottone nichelato a barretta mobile.</p> <p>apertura mm 12 20 25 30</p> <p>Tipo gigante 40 50 65</p>	<p>Spider holder in acid corrosion resistant alloy. Fitted with revolving PVC rollers which allow the burette to be automatically raised or lowered using just one hand. Single burette model. Double burette model.</p> <p>Hoffmann pinchcock in nickel-plated brass with movable bar. bar aperture in mm 12 20 25 30</p> <p>Giant size 40 50 65</p>
 <p data-bbox="464 960 624 987">Art. 25FC0400</p>  <p data-bbox="1058 960 1339 1010">Art. 25FC0409 - 25FC0413 Art. 25FC0415 - 25FC0417</p>		
<p>25FC0418 25FC0419 25FC0420 25FC0421</p> <p>25FC0430 25FC0433 25FC0431 25FC0432</p> <p>25FC0434 25FC0435 25FC0436</p>	<p>Pinze di Mohr in ottone nichelato mm. lung. 50 60 70 80</p> <p>Pinze per palloni a gambo libero a branche tonde, rivestimento interno in sughero: in acciaio inox 18/8, apertura mm 30 ø 10 in acciaio inox 18/8, apertura mm 100 ø 12 in lega leggera apertura mm 40 ø 12 in lega leggera apertura mm 50 ø 12</p> <p>Pinze per palloni con morsetto a branche tonde, rivestimento interno in sughero: in acciaio inox 18/8, apertura mm 30 in lega leggera apertura mm 40 in lega leggera apertura mm 50</p>	<p>Mohr pinchcock in nickel-plated brass length in mm 50 60 70 80</p> <p>Holders for round-bottomed flasks with free shank and curved cork-lined jaws: in 18/8 stainless steel, aperture 30 mm ø 10 in 18/8 stainless steel, aperture 100 mm ø 12 in light alloy, aperture 40 mm ø 12 in light alloy, aperture 50 mm ø 12</p> <p>Holders for round-bottomed flasks with clamp and curved cork-lined jaws: in 18/8 stainless steel, aperture 30 mm in light alloy, aperture 40 mm in light alloy, aperture 50 mm</p>
 <p data-bbox="193 1957 472 1984">Art. 25FC0418 - 25FC0421</p>  <p data-bbox="1046 1872 1326 1899">Art. 25FC0430 - 25FC0432</p>  <p data-bbox="635 2096 914 2123">Art. 25FC0434 - 25FC0436</p>		

Art.	Descrizione	Description
<p>25FC0439 25FC0440</p> <p>25FC0445 25FC0446 25FC0447 25FC0448</p>	<p>Pinze universali in lega antiacida e anticorrosiva a branche a squadra per tubi refrigeranti, palloni, beute, con interno di sughero Modello a gambo libero: apertura mm. 30-50 \varnothing 12x200 mm. 50-80 \varnothing 12x220 mm.</p> <p>Pinze universali in lega antiacida e anticorrosiva a branche a squadra per tubi refrigeranti, palloni, beute, con interno di sughero Modello con morsetto girevole: apertura mm. 10-20 120 mm. 20-30 120 mm. 30-50 120 mm. 50-80 120 mm.</p>	<p>General purpose holders in acid and corrosion resistant alloy with square jaws for refrigerating tubes, rounded-bottom flasks, Erlenmeyer flasks, cork-lined Free shank model: aperture in mm 30-50 \varnothing 12x200 mm. 50-80 \varnothing 12x220 mm.</p> <p>General purpose holders in acid and corrosion resistant alloy with square jaws for refrigerating tubes, rounded-bottom flasks, Erlenmeyer flasks, cork-lined Revolving clamp model: aperture in mm 10-20 120 mm. 20-30 120 mm. 30-50 120 mm. 50-80 120 mm.</p>
	 <p data-bbox="411 992 695 1016" style="text-align: center;">Art. 25FC0439 - 25FC0440</p>	 <p data-bbox="999 992 1283 1016" style="text-align: center;">Art. 25FC0445 - 25FC0448</p>
<p>25FC0456</p> <p>25FC0470</p>	<p>Pinza a 4 griffe in lega leggera, apertura da mm 0 a mm 80</p> <p>Pinze per sostegno in lega antiacida e anticorrosiva ad agraffi, a gambo libero apertura mm. 10-25 \varnothing 9x165 mm.</p>	<p>4 jaw holder in light alloy with 0 to 80 mm aperture</p> <p>Supporting holders with claws and free shank, in acid and corrosion resistant light alloy aperture in mm 10-25 \varnothing 9x165 mm.</p>
	 <p data-bbox="416 1731 576 1756" style="text-align: center;">Art. 25FC0456</p>	 <p data-bbox="1031 1720 1190 1744" style="text-align: center;">Art. 25FC0470</p>

Art.	Descrizione	Description
	Portaprovette a tre piani in acciaio inox 18/8	Burette holder in 18/8 stainless steel
	N. di fori \varnothing fori mm	N° of holes \varnothing holes mm
25FC0526	12 20 180x60x80 mm.	12 20 180x60x80 mm.
25FC0527	24 20 320x60x80 mm.	24 20 320x60x80 mm.
25FC0529	48 20 320x150x80 mm.	48 20 320x150x80 mm.
25FC0536	Portaprovette in alluminio a 8 fori \varnothing fori mm13 e 18	Test tube holders In aluminium with 8 holes, hole \varnothing : 13 and 18 mm
25FC0537	Portaprovette in acciaio inox a 8 fori \varnothing fori mm13 e 18	Test tube holders In stainless steel with 8 holes, hole \varnothing : 13 and 18 mm
	Triangoli per crogioli , in refrattario con filo in ferro	Crucible triangles in refractory material with iron wire
25FC0584	mm 40	40 mm
25FC0585	mm 50	50 mm
25FC0586	mm 60	60 mm



Art. 25FC0525 - 25FC0529



Art. 25FC0536 - 25FC0537

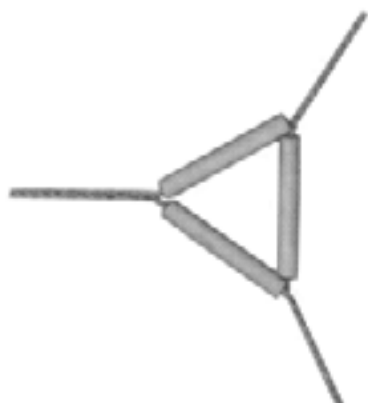

Art. 25FC0584 - 25FC0586

Art.	Descrizione	Description																
25FC0569 25FC0570 25FC0571	Sostegno a treppiede in tondino, in acciaio inox 18/8 <table border="0"> <tr> <td>∅ mm</td> <td>h. mm</td> </tr> <tr> <td>100</td> <td>180</td> </tr> <tr> <td>120</td> <td>220</td> </tr> <tr> <td>150</td> <td>230</td> </tr> </table>	∅ mm	h. mm	100	180	120	220	150	230	Tripod support in 18/8 stainless steel rod <table border="0"> <tr> <td>∅ mm</td> <td>h mm</td> </tr> <tr> <td>100</td> <td>180</td> </tr> <tr> <td>120</td> <td>220</td> </tr> <tr> <td>150</td> <td>230</td> </tr> </table>	∅ mm	h mm	100	180	120	220	150	230
∅ mm	h. mm																	
100	180																	
120	220																	
150	230																	
∅ mm	h mm																	
100	180																	
120	220																	
150	230																	
25FC0541/K 25FC0542/K 25FC0544/K	Reticella spargifiamma in ferro zincato, piane, con disco in ceramica <table border="0"> <tr> <td>mm</td> </tr> <tr> <td>120x120</td> </tr> <tr> <td>150x150</td> </tr> <tr> <td>200x200</td> </tr> </table>	mm	120x120	150x150	200x200	Wire gauze in flat galvanised iron with ceramic disc <table border="0"> <tr> <td>mm</td> </tr> <tr> <td>120x120</td> </tr> <tr> <td>150x150</td> </tr> <tr> <td>200x200</td> </tr> </table>	mm	120x120	150x150	200x200								
mm																		
120x120																		
150x150																		
200x200																		
mm																		
120x120																		
150x150																		
200x200																		



Art. 25FC0569 - 25FC0571

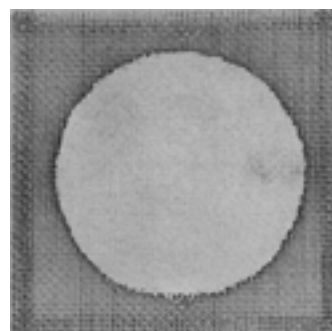

Art. 25FC0541/K - 25FC0544/K

25FC0600 25FC0601 25FC0602 25FC0603 25FC0604 25FC0606 25FC0607 25FC0608 25FC0609	Spazzolini con terminale a ciuffo in ferro zincato, con spazzole in setola	Brushes with tuft tip in galvanised iron wire, bristle brushes																																								
	<table border="0"> <tr> <td>∅ spazzole mm</td> <td>lungh. tot mm</td> <td>∅ brushes mm</td> <td>overall length mm</td> </tr> <tr> <td>10x100</td> <td>330</td> <td>10x100</td> <td>330</td> </tr> <tr> <td>15x100</td> <td>330</td> <td>15x100</td> <td>330</td> </tr> <tr> <td>20x100</td> <td>330</td> <td>20x100</td> <td>330</td> </tr> <tr> <td>25x100</td> <td>330</td> <td>25x100</td> <td>330</td> </tr> <tr> <td>30x100</td> <td>330</td> <td>30x100</td> <td>330</td> </tr> <tr> <td>40x120</td> <td>400</td> <td>40x120</td> <td>400</td> </tr> <tr> <td>50x120</td> <td>400</td> <td>50x120</td> <td>400</td> </tr> <tr> <td>60x120</td> <td>450</td> <td>60x120</td> <td>450</td> </tr> <tr> <td>80x120</td> <td>450</td> <td>80x120</td> <td>450</td> </tr> </table>	∅ spazzole mm	lungh. tot mm	∅ brushes mm	overall length mm	10x100	330	10x100	330	15x100	330	15x100	330	20x100	330	20x100	330	25x100	330	25x100	330	30x100	330	30x100	330	40x120	400	40x120	400	50x120	400	50x120	400	60x120	450	60x120	450	80x120	450	80x120	450	
	∅ spazzole mm	lungh. tot mm	∅ brushes mm	overall length mm																																						
	10x100	330	10x100	330																																						
	15x100	330	15x100	330																																						
	20x100	330	20x100	330																																						
	25x100	330	25x100	330																																						
	30x100	330	30x100	330																																						
	40x120	400	40x120	400																																						
	50x120	400	50x120	400																																						
60x120	450	60x120	450																																							
80x120	450	80x120	450																																							
25FC0610 25FC0611 25FC0612 25FC0613 25FC0614 25FC0616 25FC0617 25FC0618 25FC0619	Spazzolini con terminale a ciuffo in ferro zincato, con spazzole in nylon	Brushes with tuft tip in galvanised iron wire, nylon brushes																																								
	<table border="0"> <tr> <td>∅ spazzole mm</td> <td>lungh. tot mm</td> <td>∅ brushes mm</td> <td>overall length mm</td> </tr> <tr> <td>10x100</td> <td>330</td> <td>10x100</td> <td>330</td> </tr> <tr> <td>15x100</td> <td>330</td> <td>15x100</td> <td>330</td> </tr> <tr> <td>20x100</td> <td>330</td> <td>20x100</td> <td>330</td> </tr> <tr> <td>25x100</td> <td>330</td> <td>25x100</td> <td>330</td> </tr> <tr> <td>30x100</td> <td>330</td> <td>30x100</td> <td>330</td> </tr> <tr> <td>40x120</td> <td>400</td> <td>40x120</td> <td>400</td> </tr> <tr> <td>50x120</td> <td>400</td> <td>50x120</td> <td>400</td> </tr> <tr> <td>60x120</td> <td>450</td> <td>60x120</td> <td>450</td> </tr> <tr> <td>80x120</td> <td>450</td> <td>80x120</td> <td>450</td> </tr> </table>	∅ spazzole mm	lungh. tot mm	∅ brushes mm	overall length mm	10x100	330	10x100	330	15x100	330	15x100	330	20x100	330	20x100	330	25x100	330	25x100	330	30x100	330	30x100	330	40x120	400	40x120	400	50x120	400	50x120	400	60x120	450	60x120	450	80x120	450	80x120	450	
	∅ spazzole mm	lungh. tot mm	∅ brushes mm	overall length mm																																						
	10x100	330	10x100	330																																						
	15x100	330	15x100	330																																						
	20x100	330	20x100	330																																						
	25x100	330	25x100	330																																						
	30x100	330	30x100	330																																						
	40x120	400	40x120	400																																						
	50x120	400	50x120	400																																						
60x120	450	60x120	450																																							
80x120	450	80x120	450																																							



Art. 25FC0600 - 25FC0619

Art.	Descrizione	Description
	Spazzolini con terminale a ventaglio in filo di ferro zincato, con spazzole in setola ø spazzole mm lungh. tot mm	Brushes with fan-shaped tip in galvanised iron wire, bristle brushes ø brushes mm overall length mm
25FC0625	10x100 300	10x100 300
25FC0626	15x100 300	15x100 300
25FC0627	20x100 300	20x100 300
25FC0628	25x100 300	25x100 300
25FC0629	30x100 300	30x100 300
25FC0630	35x100 300	35x100 300
25FC0631	40x120 350	40x120 350
25FC0632	50x120 350	50x120 350
25FC0633	60x120 400	60x120 400
25FC0634	80x120 400	80x120 400
	Spazzolini con terminale a ventaglio in filo di ferro zincato, con spazzole in nylon ø spazzole mm lungh. tot mm	Brushes with fan-shaped tip in galvanised iron wire, nylon brushes ø brushes mm overall length mm
25FC0635	10x100 300	10x100 300
25FC0636	15x100 300	15x100 300
25FC0637	20x100 300	20x100 300
25FC0638	25x100 300	25x100 300
25FC0639	30x100 300	30x100 300
25FC0640	35x100 300	35x100 300
25FC0641	40x120 350	40x120 350
25FC0642	50x120 350	50x120 350
25FC0643	60x120 400	60x120 400
25FC0644	80x120 400	80x120 400
	Spazzolini per burette a manico lungo con terminale a ciuffo, in filo di ferro zincato, con spazzole in setola ø spazzole mm lungh. tot mm	Brushes for burettes with long handles and tuft tip, in galvanised iron wire, bristle brushes ø brushes mm overall length mm
25FC0620	10x120 830	10x120 830
25FC0621	15x120 830	15x120 830
25FC0622	Spazzolino per bicchieri con manico in legno, mm. 380	Brush for beakers, with wooden handle, 380 mm.
25FC0624	Spazzolino per palloni, snodabile da 40 a 220 mm., con manico in legno, lungh. tot. mm 560	Brush for round-bottomed flasks, articulated from 40 to 220 mm, with wooden handle, overall length 560 mm.



Art. 25FC0625 - 25FC0644



Art. 25FC0620 - 25FC0621



Art. 25FC0622



Art. 25FC0624

Art.	Descrizione	Description
25FC0675 25FC0676 25FC0677 25FC0678 25FC0679	Sostegni ad anelli a gambo libero in acciaio inox 18/8 ø mm 50 ø 10x200 85 ø 10x180 115 ø 10x160 135 ø 12x150 150 ø 12x150	Free shank ring supports in 18/8 stainless steel ø mm 50 ø 10x200 85 ø 10x180 115 ø 10x160 135 ø 12x150 150 ø 12x150
25FC0680 25FC0681 25FC0682	Sostegni ad anelli con morsetto , in acciaio inox 18/8 ø mm 50 85 115	Ring supports with clamp in 18/8 stainless steel ø mm 50 85 115
25FC0685	Sostegno ad anelli opposti in ottone lucido, ø anelli mm 45	Opposed ring support in mirror-finish brass, ø rings 45 mm.

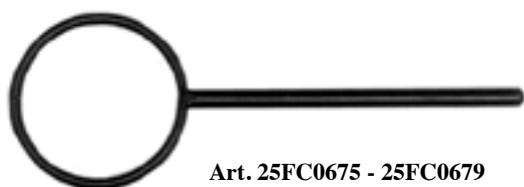

Art. 25FC0675 - 25FC0679



Art. 25FC0680 - 25FC0682



Art. 25FC0685

25FC0689

Sostegno di Omeis ad altezza variabile, in ottone cromato
 h. min. mm h. max mm
 140 220

Variable height Omeis support, in chromium-plated brass
 min. h mm max. h mm
 140 220



Art. 25FC0689

Art.	Descrizione	Description
25FC0700	Sostegno completo con anelli porta imbuto. Base in acciaio verniciato, asta in alluminio. Base 90x180 mm. Asta \varnothing 8x400 mm.	Support complete with funnel holder rings. Painted steel base, aluminium rod. Base 90x180 mm. Rod \varnothing 8x400 mm.
25FC0708	Sostegno in acciaio porcellanato bianco con asta \varnothing 12x600 mm, modello ad un posto , mm 180x200.	Porcelain-coated steel support with rod \varnothing 12x600 mm Single place model 180x200 mm.
25FC0709	Modello a due posti , mm 180x360. Sostegno a treppiede in ghisa verniciato a forno completo con asta in acciaio inox 18/8 completo con asta in acciaio inox 18/8	Double place model , 180x360. Stove-enamelled cast iron tripod complete with 18/8 stainless steel rod
	branche da mm asta \varnothing x h	branches mm rod \varnothing x h
25FC0721	90 8x450	90 8x450
25FC0722	110 10x500	110 10x500
25FC0724	160 12x600	160 12x600
25FC0725	190 12x800	190 12x800



Art. 25FC0709



Art. 25FC0721 - 25FC0725



Art. 25FC0700







Art.	Descrizione	Description
25FC0711 25FC0712 25FC0713	Sostegno rettangolare in acciaio verniciato a forno, completo di asta inox. base mm asta \varnothing x h. 140x165 10x500 200x260 12x600 250x400 15x1000	Rectangular base support in stove-enamelled steel, complete with stainless steel rod. base mm rod \varnothing x h. 140x165 10x500 200x260 12x600 250x400 15x1000
25FC0833 25FC0834	Sostegno ad U in ghisa con asta in acciaio cromato apertura branche mm asta \varnothing x h 230x660 15x1000 180x460 12x800	Cast iron U support with chromium-plated steel rod aperture of jaws \varnothing rod x h 230x660 15x1000 180x460 12x800





Art. 25FC0711 - 25FC0713



Art. 25FC0833 - 25FC0834

Art.	Descrizione	Description
25FC0760 25FC0757 25FC0759 25FC0761 25FC0763 25FC0764 25FC0765 25FC0766	Spatola doppia , dritta, flessibile in acciaio 18/8 Lunghezza totale mm larghezza paletta mm 120 6x30 150 6x30 210 6x30 150 9x40 210 9x40 250 17x50 300 20x60 400 25x70	Double blade spatula , straight and flexible, in 18/8 stainless steel Total length mm blade width mm 120 6x30 150 6x30 210 6x30 150 9x40 210 9x40 250 17x50 300 20x60 400 25x70
	 <p style="text-align: center;">Art. 25FC0757 - 25FC0760</p>	 <p style="text-align: center;">Art. 25FC0761 - 25FC0766</p>
25FC0772 25FC0773 25FC0775	Spatola doppia curva flessibile, in acciaio inox 18/8 Lunghezza totale mm larghezza paletta mm 120 6x30 150 9x40 210 9x45	Double blade spatula , curved and flexible in 18/8 stainless steel Total length mm blade width mm 120 6x30 150 9x40 210 9x45
25FC0785 25FC0787	Spatole semplici di Ghon in acciaio 18/8 Lunghezza totale mm larghezza paletta mm 150 6x30 210 6x30	Simple Ghon spatula , in 18/8 stainless steel Total length mm blade width mm 150 6x30 210 6x30
	 <p style="text-align: center;">Art. 25FC0772 - 25FC0775</p>	 <p style="text-align: center;">Art. 25FC0785 - 25FC0787</p>
25FC0793 25FC0795	Spatola con cucchiaio in acciaio inox 18/8 Lunghezza totale mm larghezza paletta mm 150 20x25 210 25x30	Scoop spatula in 18/8 stainless steel Total length mm blade width mm 150 20x25 210 25x30
25FC0801 25FC0803	Spatola a due palette larghe rigide in acciaio inox 18/8 Lunghezza totale mm larghezza paletta mm 150 20x25 210 25x30	Double blade spatula , wide and stiff, in 18/8 stainless steel Total length mm blade width mm 150 20x25 210 25x30
	 <p style="text-align: center;">Art. 25FC0793 - 25FC0795</p>	 <p style="text-align: center;">Art. 25FC0801 - 25FC0803</p>

Art.	Descrizione	Description																												
25FC0809 25FC0811	Spatola con doppio cucchiaio in acciaio inox 18/8 Lunghezza totale mm 150 210	Double scoop spatula in 18/8 stainless steel Total length mm 150 210																												
25FC0824	Spatola in acciaio inox 18/8, flessibile con manico in fibra. Lunghezza lama mm 50- Larghezza lama mm 10	Spatula , flexible, in 18/8 stainless steel with fibre handle. Blade length 50 mm - Blade width 10 mm																												
 <p data-bbox="405 611 683 636">Art. 25FC0809 - 25FC0811</p>		 <p data-bbox="1098 593 1251 618">Art. 25FC0824</p>																												
25CI6412/0 25CI6412/5 25CI6413/5 25CI6414/0 25CI6414/5	<table border="0"> <tr> <td colspan="2">Spatola cuoco inox</td> </tr> <tr> <td>Lunghezza lama mm</td> <td>larghezza lama mm</td> </tr> <tr> <td>100</td> <td>25</td> </tr> <tr> <td>140</td> <td>27</td> </tr> <tr> <td>220</td> <td>32</td> </tr> <tr> <td>260</td> <td>34</td> </tr> <tr> <td>300</td> <td>36</td> </tr> </table>	Spatola cuoco inox		Lunghezza lama mm	larghezza lama mm	100	25	140	27	220	32	260	34	300	36	<table border="0"> <tr> <td colspan="2">Spatula steel cook</td> </tr> <tr> <td>Blade length mm</td> <td>Blade width mm</td> </tr> <tr> <td>100</td> <td>25</td> </tr> <tr> <td>140</td> <td>27</td> </tr> <tr> <td>220</td> <td>32</td> </tr> <tr> <td>260</td> <td>34</td> </tr> <tr> <td>300</td> <td>36</td> </tr> </table>	Spatula steel cook		Blade length mm	Blade width mm	100	25	140	27	220	32	260	34	300	36
Spatola cuoco inox																														
Lunghezza lama mm	larghezza lama mm																													
100	25																													
140	27																													
220	32																													
260	34																													
300	36																													
Spatula steel cook																														
Blade length mm	Blade width mm																													
100	25																													
140	27																													
220	32																													
260	34																													
300	36																													
 <p data-bbox="684 1214 991 1238">Art. 25CI6412/0 - 25CI6414/5</p>																														

Art.	Descrizione	Description
	APPARECCHIATURE VARIE PER LABORATORI	VARIOUS LABORATORY EQUIPMENT
	Tavolino elevatore con piani in acciaio inox 18/8, molto robusto e preciso	Lifting table with tops in 18/8 stainless steel, extremely sturdy and precise
	mod. mm h. min. mm h. max mm	mod. mm min. h mm max. h mm
09FC0851	130x160 60 245	130x160 60 245
09FC0852	200x200 65 300	200x200 65 300
09FC0853	300x300 80 450	300x300 80 450
	Carico per tavolini elevatori	Load for lifting tables
	Mod. mm. Statico Kg. Dinamico Kg.	Mod. mm. Static Kg. Dynamic Kg.
	130x60 15 10	130x60 15 10
	200x200 30 20	200x200 30 20
	300x300 50 25	300x300 50 25



Art. 09FC0851 - 09FC0853

Carrelli in acciaio inox 18/8, ruote con \varnothing 100 mm. e maniglia, SERIE 122. Altezza totale mm. 900.

09FC2700/00 Modello due piani (spazio tra i ripiani mm. 600)
09FC2700/01 Dimensione piani mm. 600x400.
09FC2700/02 Dimensione piani mm. 700x500.
 Dimensione piani mm. 900x600.

09FC2700/03 Modello a tre piani (spazio tra i ripiani mm. 330)
09FC2700/04 Dimensione piani mm. 600x400.
09FC2700/05 Dimensione piani mm. 700x500.
 Dimensione piani mm. 900x600.

Trolleys in 18/8 stainless steel, \varnothing 100 mm wheels and handle , SERIES 122. Overall height 900 mm.

Model with two tiers(distance between tiers 600 mm)
 Dimensions of tiers 600x400 mm.
 Dimensions of tiers 700x500 mm.
 Dimensions of tiers 900x600 mm.

Model with three tiers (distance between tiers 330 mm)
 Dimensions of tiers 600x400 mm.
 Dimensions of tiers 700x500 mm.
 Dimensions of tiers 900x600 mm.



Art. 09FC2700/00...09FC2700/02



Art. 09FC2700/03...09FC2700/05